

KM-1301S_H-E

STACKABLE ICE CUBER

Item # _____

Project: _____

Qty: _____

*AutoCad available on KCL

KM-1301S_H-E

6/11

Item # 13055

CUBER DIMENSIONS

W x D x H

KM-1301S_H-E
122 x 69.5 x 69.5cm

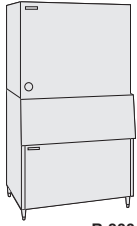

B-800

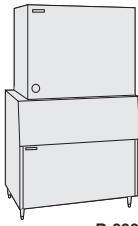

B-900

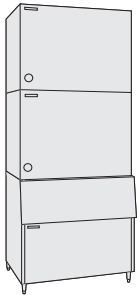

B-800

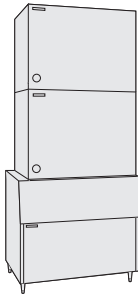

B-900

Also available on Large Bins:
B-1150SS
B-1300SS

KM-1301SAH-E

Air-Cooled
Shown on an optional
B-900



KM-1301SWH-E

Water-Cooled

KM-1301SRH-E

Remote Air-Cooled



- Up to 603 kg of ice production per 24 hours
- Durable stainless steel exterior
- Protected by *H-GUARD Plus* Antimicrobial Agent 
- CycleSaver® design 
- EverCheck® alert system 
- Individual crescent cube
- Stainless steel evaporator
- Stackable for 1206 kg per 24 hour ice production in the same floor space
- Removable air filters
- R-404A Refrigerant



Warranty

Contact factory for warranty information.



Hoshizaki

KM-130IS_H-E STACKABLE ICE CUBER

DIMENSIONS
W x D x H
KM-130IS_H-E
122 x 69.5 x 69.5cm

STACKABLE ICE CUBER

- Air-cooled
- Water-cooled
- Remote Air-cooled

AIR - COOLED

Water Temp ° C.	10°	21°	32°	
Air Temp ° C.	21°	505	491	450
	27°	494	471	419
	32°	491	455	407

WATER - COOLED

Water Temp ° C.	10°	21°	32°	
Air Temp ° C.	21°	603	591	562
	27°	594	576	539
	32°	591	562	528

REMOTE AIR - COOLED

Water Temp ° C.	10°	21°	32°	
Air Temp ° C.	21°	576	559	526
	27°	563	537	499
	32°	559	518	482

UTILITY CONSUMPTION at 32°C A/ 21°C W

Model Number	Ice Production Per Cycle		KWH per 45 Kg	Potable Water Liters per 45 kg	Condenser Water Liters per 45 kg
	Kg	Cubes			
KM-1301SAH-E	13.2	1440	5.1	59.0	N/A
KM-1301SWH-E	14	1440	3.5	59.0	N/A
KM-1301SRH-E	14.3	1440	4.4	59.0	N/A

SPECIFICATIONS

Model Number	Condenser	Amperage	Min. Circuit Ampacity	Shipping Weight
KM-1301SAH-E	Air-Cooled	11.8	20	143 kg
KM-1301SWH-E	Water-Cooled	10.7	20	143 kg
KM-1301SRH-E	Remote Air-Cooled	12.3	20	143 kg

STORAGE BINS

Model Number	Application Capacity
B-800	363 kg
B-900	409 kg
B-1150	522 kg
B-1300	578 kg
B-1500	676 kg
B-1650	728 kg

ELECTRICAL & PLUMBING/KM-130IS_H-E

- 220 - 240V/50/1
- 20 amp Max Fuse
- 1.27cm OD copper or equivalent independent potable water supply
- 3/4" FPT independent drain connection

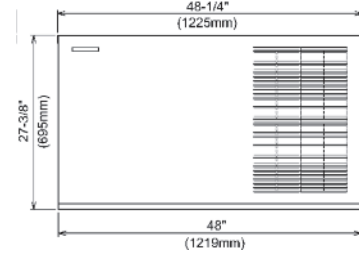

FRONT VIEW

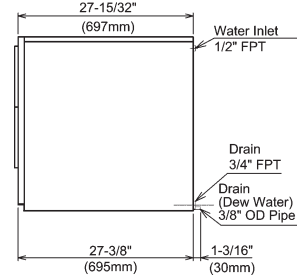

SIDE VIEW

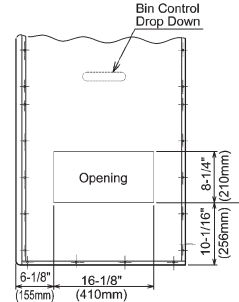

ICE DROP ZONE

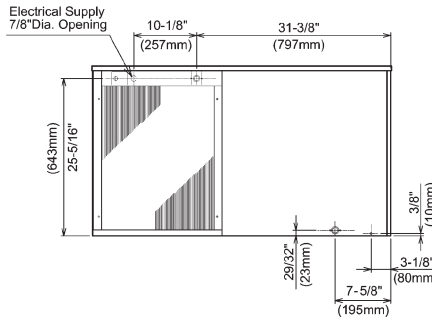

AIR-COOLED UNIT

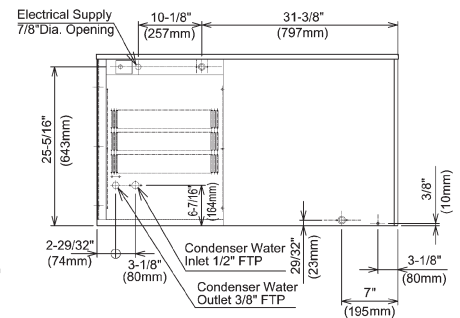

WATER-COOLED UNIT

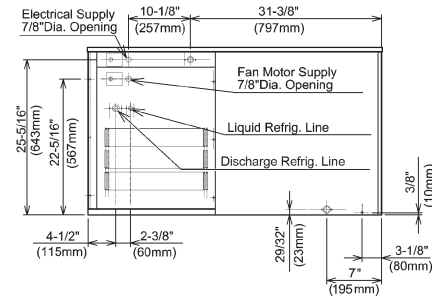

REMOTE AIR-COOLED UNIT

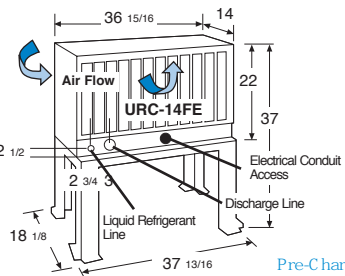

URC -14FE Remote Condenser (Sold Separately)
For Use with KM-1301SRH-E

Pre-Charged Tubing Kits
(Sold Separately)
20' R404-2068-2
35' R404-3568-2
55' R404-5568-2

Voltage supply for the URC Remote Condenser is supplied from the Ice Maker. No additional circuit is required.

OPERATING LIMITS

- Ambient Temp Range 7 - 38°C
- Water Temp Range 7 - 32°C
- Water Pressure 0.7 - 8 kg/cm²
- Voltage Range 198 - 254V

SERVICE

- Panels easily removed and all components accessible for service.
- Removable/cleanable air filters.



© HOSHIZAKI AMERICA, INC.

618 Hwy. 74 S., Peachtree City, GA 30269

TEL 1-800-438-6087

FAX 1-800-345-1325

www.hoshizaki.com

Printed in U.S.A.

